

# GRACO®

## Open Top Swing

### OWNER'S MANUAL

Model No. \_\_\_\_\_  
Serial No. \_\_\_\_\_

Dear Customer,

Please fill in the model and serial numbers above from the label inside the battery compartment of your new swing.

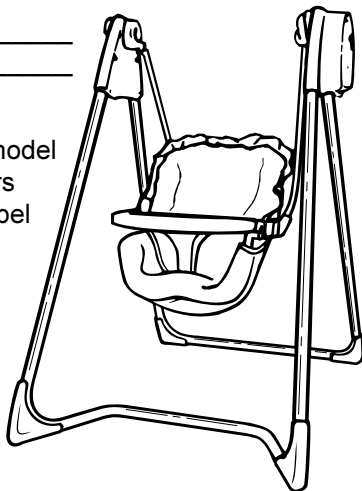

**Model No. 1423, 1424, 1428**

### Congratulations on your purchase of a Graco® swing!

Graco is the recognized leader in the design and manufacture of quality baby swings. We believe your new Graco® swing is a wise choice, promising many hours of enjoyment for your baby.

Before using your swing, please take a few minutes to read this Owner's Manual. The short time you spend reading these instructions will help you use your swing properly.

**Please save your Owner's Manual for future use.**

### Customer Satisfaction

Our goal is to make every product the best it can be! We are also committed to supporting our products after purchase. If you would like to speak with Graco about your product, please contact our **Customer Service Department at 1-800-345-4109** or visit our Internet website, [www.gracobaby.com](http://www.gracobaby.com). Our knowledgeable staff will be ready to answer any questions you may have concerning parts, use or maintenance. When you call, please have the **model and serial numbers** ready so your call may be processed quickly and efficiently.

**⚠ WARNING**

**Failure to follow these warnings could result in serious injury or death.**

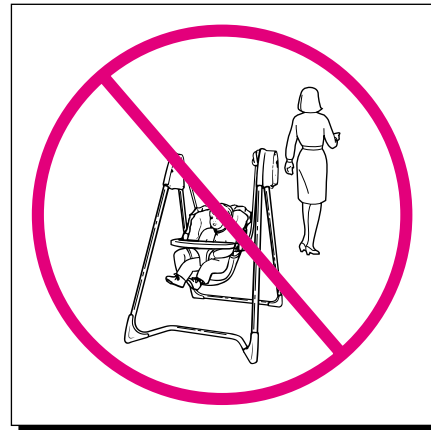

**Never leave child unattended.  
Always keep your child in view.**



**Strings can cause strangulation.  
DO NOT place items with a string around your child's neck, such as hood strings or pacifier cords.  
DO NOT suspend strings over the swing or attach strings to toys.**

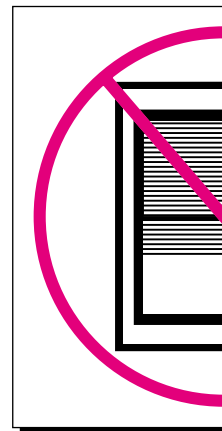

**STRANGULATION HAZARD  
DO NOT place child in location where child could become entangled, such as window blinds, drapes, phone cords, etc.**

**THIS PRODUCT REQUIRES ADULT ASSEMBLY.**

**FOLLOW ASSEMBLY INSTRUCTIONS CAREFULLY.**

If you experience any difficulties, please contact the Customer Service Department.

**DO NOT USE SWING** without the seat cover.

**DISCONTINUE USING YOUR SWING** should it become damaged or broken.

# WARNING

Read the manual and the assembly instructions carefully to avoid serious injury or death.

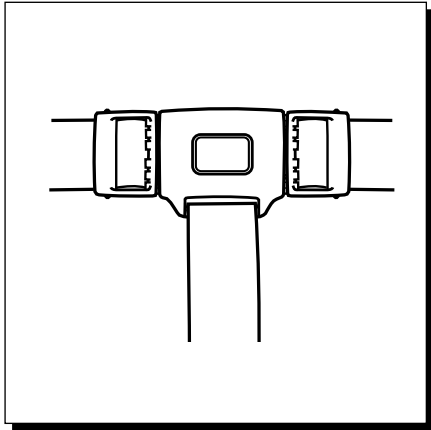

Avoid serious injury from falling or sliding out. Always use seat belt.

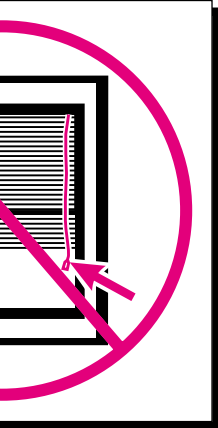

**CHOKING HAZARD:** Do not use swing in any room where there are cords, such as blind cords, window cords, etc.



**DO NOT** use if child weighs over 25 pounds (11.3 kg) or becomes too active to safely use the swing.

## CARE AND MAINTENANCE

**FROM TIME TO TIME CHECK YOUR SWING** for loose screws, worn parts, torn material or stitching. Replace or repair the parts as needed. Use only Graco® replacement parts.

**REMOVABLE CLOTH SEAT COVER** may be machine washed in cold water on delicate cycle and drip-dried. **NO BLEACH.**

**TO CLEAN SWING FRAME,** use only household soap and warm water. **NO BLEACH OR DETERGENT.**

**EXCESSIVE EXPOSURE TO SUN OR HEAT** could cause fading or warping of parts.

## PARTS LIST

CHECK that you have all the parts listed below BEFORE assembling your swing. If any parts are missing, call Customer Service at 1-800-345-4109 or visit our Internet website, [www.gracobaby.com](http://www.gracobaby.com).

Tool required: Screwdriver

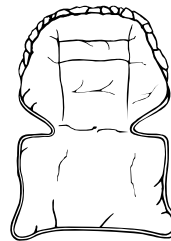

Seat cover

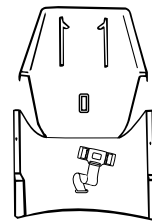

Plastic seat with crotch strap

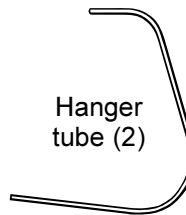

Hanger tube (2)



Tray

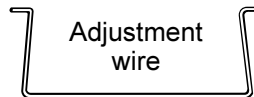

Adjustment wire

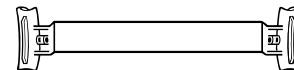

Back brace



Screw (4)

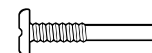

Pin screw (2)

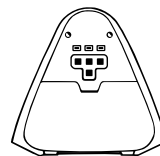

Motor housing

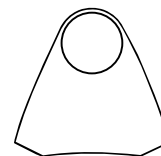

Pivot housing



Large front foot (2)



Small rear foot (2)



Seat belt

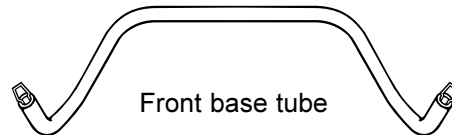

Front base tube



Plastic leg tip (4)

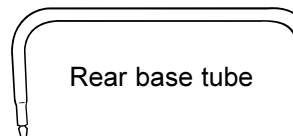

Rear base tube



Toy mount cover (2)

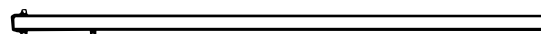

Leg (4)

## Attaching the Legs

### Step 1.

The four legs have a double button at one end and a single button beneath it.

With the hub sides facing up, place the motor housing and pivot housing on the floor. Position legs so their single buttons also face up.

Insert legs into the motor housing and pivot housing as shown. **The double buttons must fit into the channels inside the housings.**

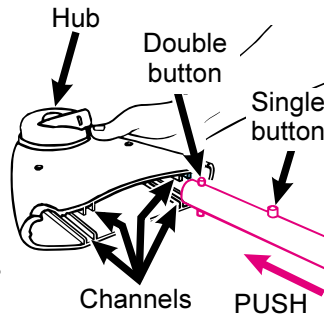

### Step 2.

Push each leg in until the double button snaps into the hole at the end of the channel. Then swing the legs outward until the single button snaps into its notch, as shown.

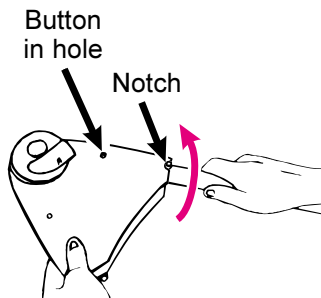

**CHECK that the legs are properly attached by twisting them in the housings. They should resist twisting. If a leg twists and buttons come out of their holes, insert leg into the housing again. Be sure to align BOTH double buttons with BOTH sets of channels inside the housings.**

## Attaching the Feet

### Step 1.

Identify the front and rear base tubes from pictures below. The feet to use with each tube can be identified by the text "FRONT BOTTOM" or "REAR BOTTOM" printed on them.

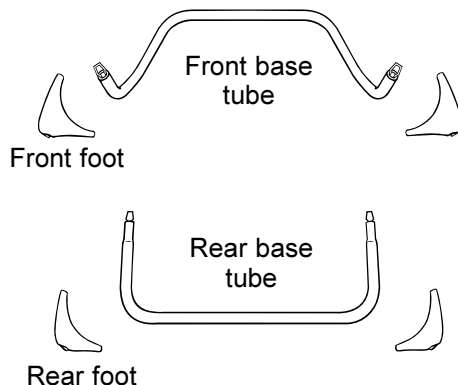

### Step 2.

Begin by inserting a screw all the way into the small hole on one foot. Position the foot **as shown at right**, so the text and viewing hole are **not** on the **short side of tube** near the wire end. Then use viewing hole to line up the end of the screw with the hole in the tube. Tighten the screw securely. Repeat above steps for the other feet.

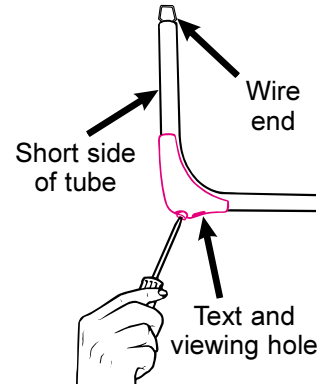

**CHECK that feet are secure by wiggling the feet.**

### Step 3.

Push a plastic tip onto all four of the feet. Tap leg tips on the floor to be sure they are completely on.

The hole in the plastic tip permits future tightening of the screw if needed.

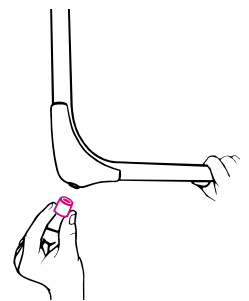

## Attaching the Base Tubes

### Step 1.

Push the legs firmly onto the rear base tube **exactly as shown.**

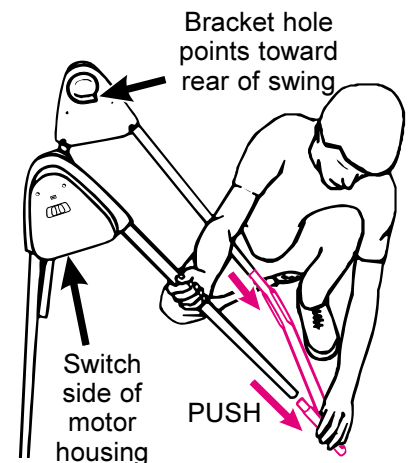

### Step 2.

Push the other two legs onto the front base tube.

**CHECK that all tubes are securely attached.**

**CHECK that the parts of the frame are assembled in the positions shown.**

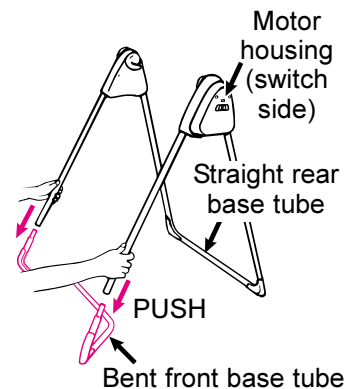

## Attaching the Hanger Tubes and Seat

### Step 1.

Move seat back fully forward onto seat armrests.

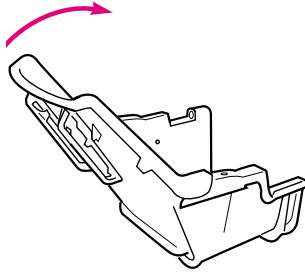

**The seat back must overlap the armrests.**

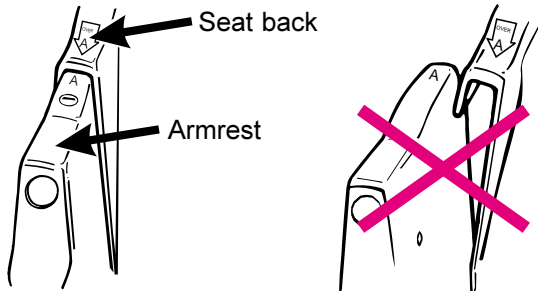

### Step 2.

Slide hanger tubes into armrests of seat as shown.

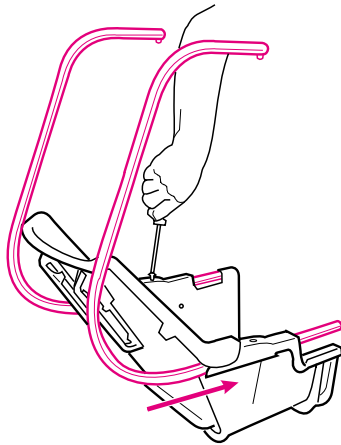

### Step 3.

Insert two pin screws through seat armrests into the holes in the hanger tubes and tighten securely.

### Step 4.

Insert the hanger tubes into the hubs as shown. Metal buttons should pop out and lock upon full insertion.

**CHECK that the hanger tubes are secure in hubs by pulling firmly on them.**

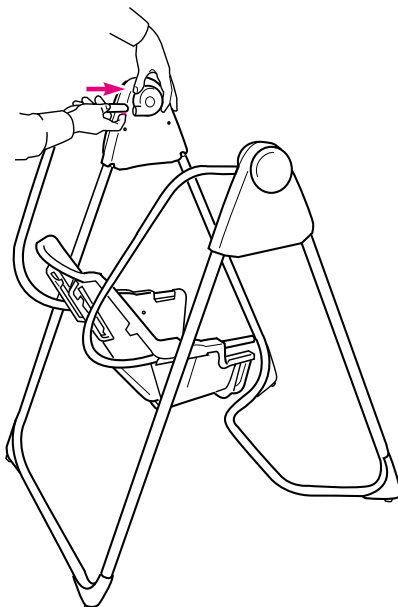

## Attaching the Back Brace

Working behind the seat, snap the four pins in the ends of the plastic back brace into the holes in the hanger tubes. The word "REAR" should be facing you.

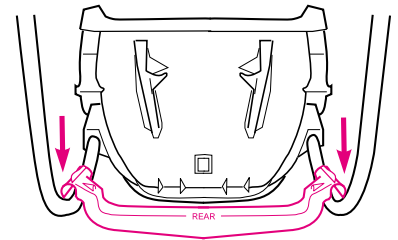

Slide adjustment wire through openings in seat back, then insert ends into back brace holes as shown.

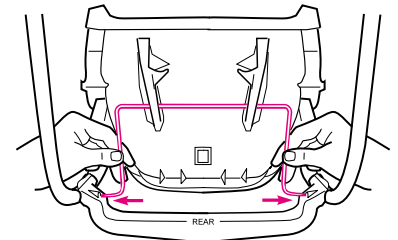

**Be sure the back brace is securely attached by pulling on it.**

## Attaching the Tray

Place one hand on the armrest and slide the tray onto the hanger tube with other hand. Push sleeve of tray all the way into the armrest of the seat until you hear it snap.

**Sleeve on tray must snap completely into the armrest.**

**Pull firmly on tray to be sure it is securely attached.**

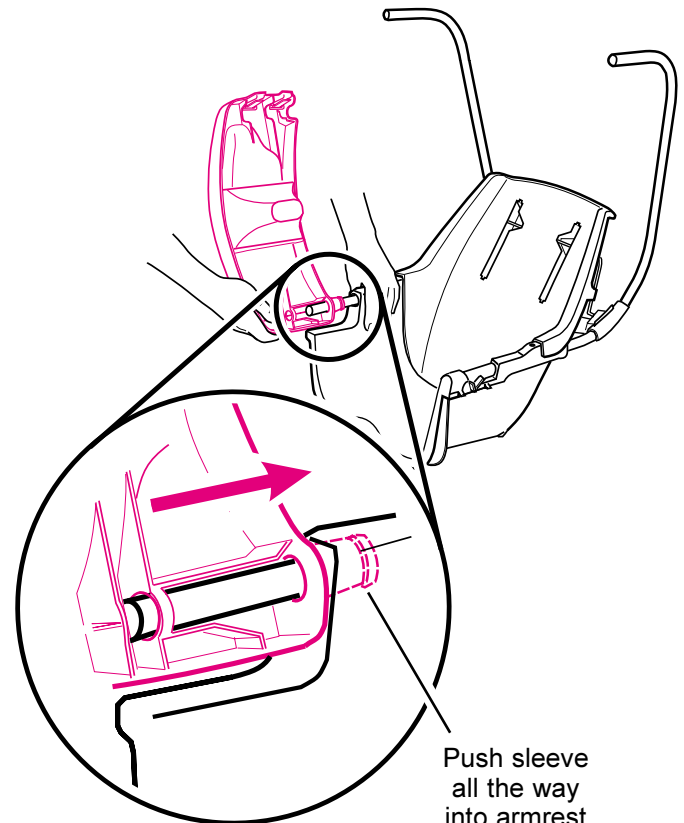

## Toy Mounting System

Your swing has a toy mounting system in the tray. This swing model does not come equipped with toys. If you would like to order toys, please see the enclosed leaflet for information. Please insert the two plastic covers as described below to fill the holes in the tray.

### To Install Covers

To insert a cover into the tray of your swing, first push one side into a notch, then push in the other side.

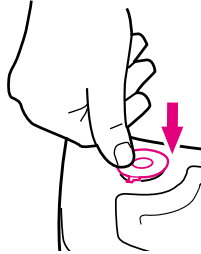

### Attaching the Seat Belt

#### Step 1.

Thread one end of the seat belt through the belt retainer as shown.

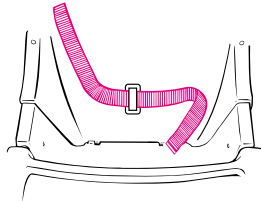

#### Step 2.

Thread both ends of seat belt through the buckles as shown.

**CHECK** that the belt is threaded correctly by pulling on the seat belt. **The belt should not slip through the buckle.**

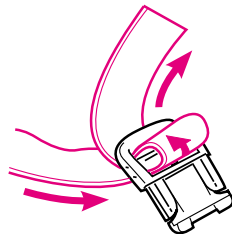

To release, push in on front of buckle.

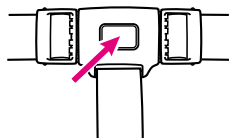

## Attaching the Seat Cover

#### Step 1.

Slide the pocket of the seat cover over the top of the seat as shown.

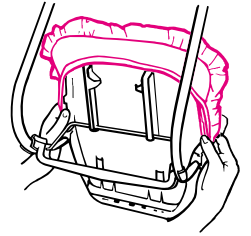

#### Step 2.

Pull crotch strap and both ends of the seat belt through the slots in the seat cover.

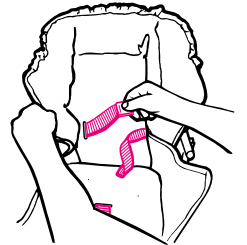

#### Step 3.

Push the elastic loop through the hole on one side of seat.

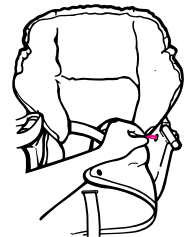

#### Step 4.

Fold cover around bottom of seat. Then fasten the hook into the elastic loop on one side as shown. Repeat on other side.

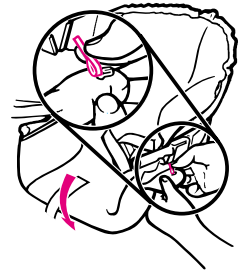

**CAUTION: Be sure the seat cover at armrest does not interfere with tray latching.**

### Using the Tray

If tray does not latch, check back brace to be sure the word "REAR" is away from the seat.

#### Step 1.

Unlatch the tray by squeezing the two latches under the tray at the same time, and lift up.

**Be careful** not to let the tray hit your baby when lifting or closing the tray.

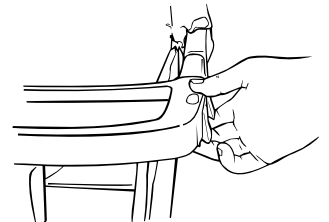

#### Step 2.

To latch tray, push it down firmly.

**▲WARNING** Tray must be latched at all times when baby is in swing. Pull up on tray to be sure it is latched.

## Reclining Back— Four Positions

Pull adjustment wire upward and pull seat backward to recline seat. Extra pressure is required to go from the third position to full recline.

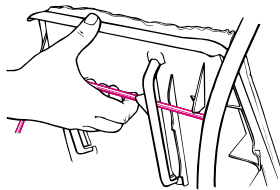

For upright position, simply lift back of seat forward.

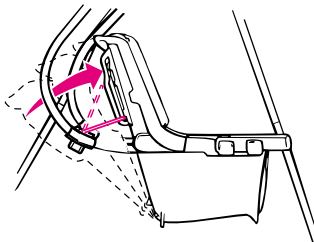

## Installing the Batteries

### Step 1.

With baby out of swing, open the battery compartment lid by inserting a coin (penny, nickel or dime) into the coin slot. After the lid pops open, swing it down and remove it.

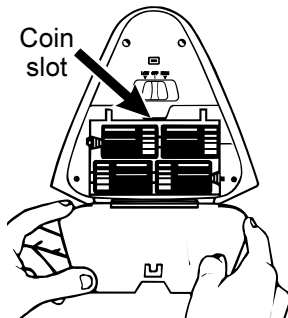

### Step 2.

Insert four “D” cells. **CHECK** that the batteries are put in correctly. Your swing will not run if the batteries are put in backwards.

### Step 3.

To replace lid, put the two tabs of the lid into the two slots in the bottom of the motor housing. Swing lid up, and press it into place until you hear the latch click.

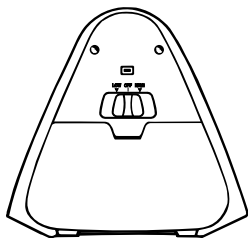

## Starting the Swing

**CHECK that all parts are securely fastened together before using the swing.**

### Step 1.

Open tray and seat belt. Place baby in the seat. (If your child is very small, you may want to use rolled-up blankets as a prop.)

### Step 2.

Place crotch strap between child’s legs and snap both side buckles to the center buckle. Adjust belt as needed to get a snug fit around your child.

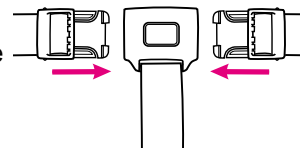

### Step 3.

Close the tray. **CHECK that the tray is latched by pulling up on the tray.**

**⚠ WARNING** Do not depend on the tray or seat belt alone to hold your baby. Always secure your baby with both the seat belt and tray when your baby is in the swing.



### Step 4.

To start swing, slide the speed button to the desired speed and give the swing a gentle push.

Observe the swinging motion for a minute. It takes time for the swing to adjust to a setting. Change setting if needed.

A small, quiet baby will swing higher on each setting than a larger, more active baby.

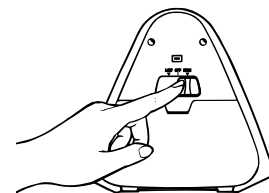

### Step 5.

To turn swing off, slide switch to the center OFF position.

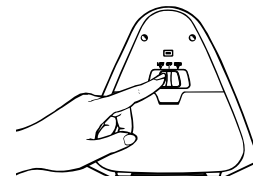

**Indicator Light-**  
Red light comes on when swing is turned on.

Your seat may be stopped at any time the motor is running without damaging the motor. Push swing to restart.

If your swing motor stops operating by itself, a protective device may have been activated. Turn off motor, wait three minutes, then restart swing.



## To Fold Swing Frame

### Step 1.

Press in the front buttons at base of motor housing and pivot housing as shown.

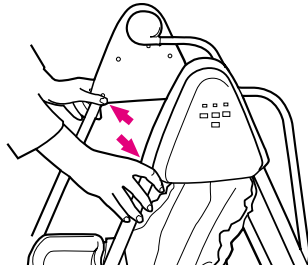

### Step 2.

Push swing legs together.

**Do not allow a child to play with the folded unit.**

To open the swing, pull out the legs gently and evenly. The buttons will snap back into place.

**Check to ensure that the frame is secure.**

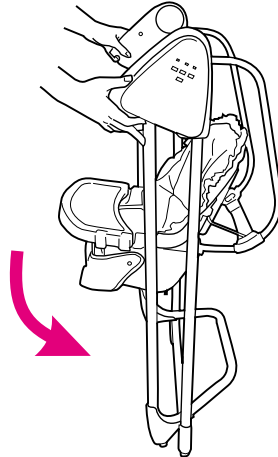

## FOR SAFE BATTERY USE:

Keep the batteries out of children's reach.

Any battery may leak battery acid if mixed with a different battery type, if inserted incorrectly (put in backwards) or if all batteries are not replaced or recharged at the same time.

Any battery may leak battery acid or explode if disposed of in fire or an attempt is made to charge a battery not intended to be recharged. Never recharge a cell of one type in a recharger made for a cell of another type.

Discard leaky batteries immediately. Leaky batteries can cause skin burns or other personal injury. When discarding batteries, be sure to dispose of them in the proper manner, according to your state and local regulations.

Always remove batteries if the swing is not going to be used for a month or more. Batteries left in the unit may leak and cause damage.

Recommended Type Batteries—Size D

- Rechargeables—Use and recharge according to manufacturer's instructions.
- Disposables—Alkaline.
- **NEVER** mix battery types.

Change batteries when swing ceases to operate satisfactorily.

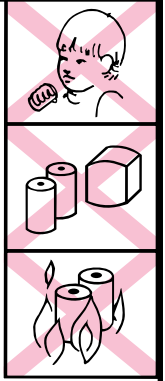

## Caring for Your Battery Powered Swing

### Problem: Possible Reasons for Problem:

- |                              |   |
|------------------------------|---|
| Swing won't operate          | <ol style="list-style-type: none"> <li>1. No batteries in swing.</li> <li>2. Batteries dead.</li> <li>3. Speed setting too low.</li> <li>4. Batteries in backwards—check “+” and “-”.</li> <li>5. Corrosion on battery terminals. Rotate batteries in place against terminals, or clean with sandpaper or steel wool if corrosion is severe.</li> <li>6. Baby leaning too far forward.</li> <li>7. Baby grabbing swing legs. (Discontinue use.)</li> <li>8. Seat not pushed high enough for a good start.</li> <li>9. Protective device activated. (Turn off motor, wait 3 minutes, then restart swing.)</li> </ol> |
| Seat doesn't swing very high | <ol style="list-style-type: none"> <li>1. Control setting too low.</li> <li>2. Blanket hanging down, causing increased wind resistance.</li> <li>3. Batteries too weak.</li> <li>4. Baby leaning too far forward.</li> <li>5. Baby too heavy or too active. (Discontinue use.)</li> <li>6. Soft carpet (swings higher on hard floors).</li> </ol>   |

If you still have problems, call our toll-free number, 1-800-345-4109.

# Replacement Parts

## Instructions for ordering swing parts:

Complete form below. Your swing model number **MUST** be included on the form to ensure proper replacement parts. **Your model number can be found on a sticker beneath the swing motor. Payment must accompany your order.**

<b>Parts List:</b>	<b>Price:*</b>
Plastic seat .....	\$21.00
with strap & buckle	
Cloth seat cover .....	\$14.00
Hanger tube .....	\$13.00
Seat belt .....	\$ 5.00
Tray .....	\$13.00
Adjustment wire .....	\$ 7.00
Back brace .....	\$ 7.00
Hardware .....	\$ 5.00
Motor housing .....	\$25.00
Pivot housing .....	\$10.00
Large front foot (2) .....	\$ 5.00
Small rear foot (2) .....	\$ 5.00
Front base tube .....	\$ 7.00
Rear base tube .....	\$10.00
Leg (each) .....	\$ 7.00

\* Prices subject to change without notice.

### IF YOU NEED HELP

If you have any questions or if you need any part not listed, please call toll-free:

**1-800-345-4109**

or visit our Internet website, [www.gracobaby.com](http://www.gracobaby.com).

Return the form below with payment to:  
**GRACO CHILDREN'S PRODUCTS INC.**  
**CUSTOMER SERVICE DEPARTMENT**  
**P.O. BOX 100, MAIN STREET**  
**ELVERSON, PA 19520**

<b>Model Number</b>	<b>SHIP TO:</b>
(Must be filled in)	Name _____
<input type="checkbox"/> Plastic seat with strap & buckle	Address _____
<input type="checkbox"/> Cloth seat cover	City, State, Zip _____
<input type="checkbox"/> Hanger tube	(     ) _____
<input type="checkbox"/> Seat belt	Telephone _____
<input type="checkbox"/> Tray	
<input type="checkbox"/> Adjustment wire	<input type="checkbox"/> Check or money order enclosed (payable to Graco Children's Products Inc.)
<input type="checkbox"/> Back brace	<input type="checkbox"/> Charge to credit card:
<input type="checkbox"/> Hardware	<input type="checkbox"/> Visa
<input type="checkbox"/> Motor housing	<input type="checkbox"/> MasterCard
<input type="checkbox"/> Pivot housing	<input type="checkbox"/> Discover
<input type="checkbox"/> Large front foot (2)	
<input type="checkbox"/> Small rear foot (2)	
<input type="checkbox"/> Front base tube	
<input type="checkbox"/> Rear base tube	
<input type="checkbox"/> Leg	
Total: _____	Account #: _____
Shipping & handling: <u>    \$5.00    </u>	Expiration date: _____
6% sales tax (PA only): _____	Signature: _____
Total amount due: _____	



# GRACO®

## Mix 'N Move™ Toys

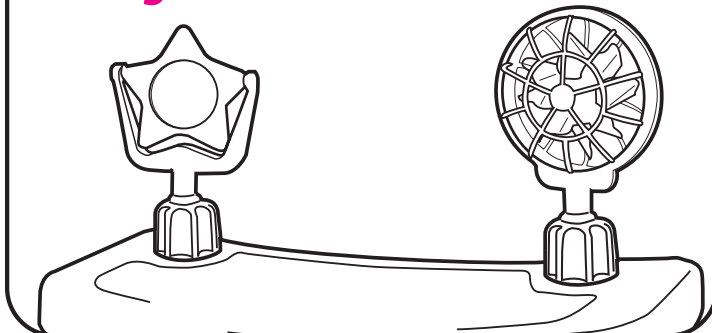

**Congratulations  
on your purchase  
of a Graco® product  
with Mix 'N Move™ Toys!**

Now your baby can enjoy an ever-changing array of amusements and take favorites along—on a swing, a highchair, or a stroller!

Our goal is to make every product the best it can be! We are also committed to supporting our products after purchase. If you need replacement parts or would like to speak to Graco about your product, please contact our **Customer Service Department at 1-800-345-4109.**

### To Install Toys

#### Step 1.

To use one of the toy mounts for the first time, you will need to remove the small plug which covers the toy mount.

#### **▲WARNING**

**Remove child from product before removing plugs.**

With the aid of a screwdriver, carefully pry up one edge of the plug until it comes off.

#### **▲WARNING**

**Throw the plug away immediately; it is not reusable.**

#### Step 2.

Insert the two prongs on the toy base into a toy mount at the notches.

#### Step 3.

Turn toy base  $\frac{1}{4}$  turn until you feel the toy snap into place. Check that toy is firmly inserted by pulling on the toy.

Toy is removable (turn it the other way with a little pressure) so that you can replace it with other toys when desired.

